

3-Level IGBT Module

电气特性:

- 1200V 沟槽栅/场终止工艺
1200V trench gate/field termination process
- 低开关损耗
Low switching losses
- V_{cesat} 正温度系数
 V_{cesat} has a positive temperature coefficient

典型应用:

- 三电平应用
3-Level-Applications
- 储能
Energy storage inverter
- APF
Annual Performance Factor
- UPS
UPS Systems

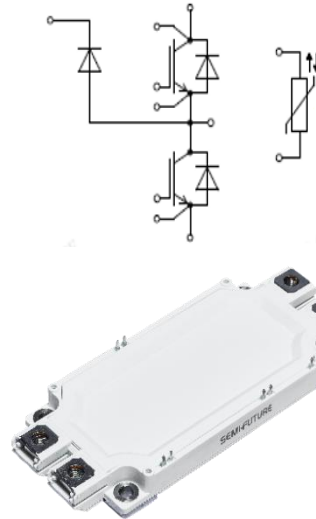

$V_{CES} = 1200V$, $I_{C\ nom} = 450A$ / $I_{CRM} = 900A$

IGBT, 逆变器 / IGBT, Inverter

最大额定值 / Maximum Ratings

Parameter	Conditions	Symbol	Value	Unit
集电极-发射极电压 Collector-Emitter voltage	$T_{vj} = 25^{\circ}C$	V_{CES}	1200	V
连续集电极直流电流 Continuous DC collector current	$T_C = 100^{\circ}C$, $T_{vj\ max} = 175^{\circ}C$	$I_{C\ nom}$	450	A
集电极重复峰值电流 Repetitive peak collector current	$t_p = 1\ ms$	I_{CRM}	900	A
总功率损耗 Total power dissipation	$T_C = 25^{\circ}C$, $T_{vj\ max} = 175^{\circ}C$	P_{tot}	1250	W
栅极-发射极电压 Gate emitter voltage	$t_p \leq 0.5\ \mu s$, $D < 0.001$	V_{GE}	± 20 30	V

特征值 / Characteristic Values

Parameter	Conditions	Symbol	Value			Unit
			Min.	Typ.	Max.	
集电极-发射极饱和电压 Collector-Emitter saturation voltage	$V_{GE}=15V, I_C=450A$ $V_{GE}=15V, I_C=450A$ $V_{GE}=15V, I_C=450A$	$T_{vj}=25^{\circ}C$ $T_{vj}=125^{\circ}C$ $T_{vj}=150^{\circ}C$	$V_{CE\ sat}$	1.61 1.89 1.96	2.1	V
栅极-发射极阈值电压 Gate-Emitter threshold voltage	$I_C=17mA, V_{GE}=V_{CE}$	$T_{vj}=25^{\circ}C$	V_{GEth}	5.3	5.8	6.5
栅电荷 Gate charge	$V_{GE}=-15V...+15V$		Q_G	3.12		μC
内部栅极电阻 Internal gate resistor	$T_{vj}=25^{\circ}C$		R_{Gint}	1.9		Ω
输入电容 Input capacitance	$f=100kHz, V_{CE}=25V,$ $V_{GE}=0V$	$T_{vj}=25^{\circ}C$	C_{ies}	34.9		nF
反向传输电容 Reverse transfer capacitance			C_{res}	1.4		
集电极-发射极截止电流 Collector-emitter cut-off current	$V_{CE}=1200V, V_{GE}=0V$	$T_{vj}=25^{\circ}C$	I_{CES}		2	mA
栅极-发射极漏电流 Gate-emitter leakage current	$V_{CE}=0V, V_{GE}=20V$	$T_{vj}=25^{\circ}C$	I_{GES}		200	nA
开通延迟时间 Turn-on delay time	$I_C=450A, V_{CE}=600V$ $V_{GE}=\pm 15V, R_G=2.0\Omega$ (电感负载) / (inductive load)	$T_{vj}=25^{\circ}C$ $T_{vj}=125^{\circ}C$ $T_{vj}=150^{\circ}C$	$t_{d\ on}$	168 221 253		
上升时间 Rise time	$I_C=450A, V_{CE}=600V$ $V_{GE}=\pm 15V, R_G=2.0\Omega$ (电感负载) / (inductive load)	$T_{vj}=25^{\circ}C$ $T_{vj}=125^{\circ}C$ $T_{vj}=150^{\circ}C$	t_r	92 100 101		
关断延迟时间 Turn-off delay time	$I_C=450A, V_{CE}=600V$ $V_{GE}=\pm 15V, R_G=2.0\Omega$ (电感负载) / (inductive load)	$T_{vj}=25^{\circ}C$ $T_{vj}=125^{\circ}C$ $T_{vj}=150^{\circ}C$	$t_{d\ off}$	427 485 501		ns
下降时间 Fall time	$I_C=450A, V_{CE}=600V$ $V_{GE}=\pm 15V, R_G=2.0\Omega$ (电感负载) / (inductive load)	$T_{vj}=25^{\circ}C$ $T_{vj}=125^{\circ}C$ $T_{vj}=150^{\circ}C$	t_f	86 155 176		
开通损耗能量 (每脉冲) Turn-on energy loss per pulse	$I_C=450A, V_{CE}=600V,$ $V_{GE}=\pm 15V, R_G=2.0\Omega,$ $di/dt=3500A/us(T_{vj}=150^{\circ}C)$ (电感负载) / (inductive load)	$T_{vj}=25^{\circ}C$ $T_{vj}=125^{\circ}C$ $T_{vj}=150^{\circ}C$	E_{on}	23.08 31.44 35.19		mJ
关断损耗能量 (每脉冲) Turn-off energy loss per pulse	$I_C=450A, V_{CE}=600V,$ $V_{GE}=\pm 15V, R_G=2.0\Omega,$ $du/dt=4100V/us(T_{vj}=150^{\circ}C)$ (电感负载) / (inductive load)	$T_{vj}=25^{\circ}C$ $T_{vj}=125^{\circ}C$ $T_{vj}=150^{\circ}C$	E_{off}	35.59 44.33 47.24		mJ
短路数据 SC data	$V_{GE}\leq 15V, V_{cc}=800V$ $V_{CEmax}=V_{CES}-L_{sCE}\cdot di/dt$ $t_p\leq 10\mu s, T_{vj}=150^{\circ}C$		I_{sc}	1700		A
结-外壳热阻 Thermal resistance, junction to case	每个 IGBT / per IGBT		R_{thJC}		0.12	K/W
在开关状态下温度 Temperature under switching conditions			$T_{vj\ op}$	-40	150	$^{\circ}C$

二极管，逆变&三电平 / Diode, Inverter&3-Level

最大额定值 / Maximum Ratings

Parameter	Conditions	Symbol	Value	Unit
反向重复峰值电压 Repetitive peak reverse voltage	$T_{vj}=25^{\circ}\text{C}$	V_{RRM}	1200	V
连续正向直流电流 Continuous DC forward current		I_F	450	A
正向重复峰值电流 Repetitive peak forward current	$t_p=1\text{ms}$	I_{FRM}	900	A
I2t-值 I2t-value	$V_R=0\text{V}, t_p=10\text{ms}, T_{vj}=125^{\circ}\text{C}$	$I2t$	34000	A^2s

特征值 / Characteristic Values

Parameter	Conditions	Symbol	Value			Unit
			Min	Typ.	Max.	
正向电压 Forward voltage	$I_F=450\text{A}, V_{GE}=0\text{V}$ $I_F=450\text{A}, V_{GE}=0\text{V}$ $I_F=450\text{A}, V_{GE}=0\text{V}$	$T_{vj}=25^{\circ}\text{C}$ $T_{vj}=125^{\circ}\text{C}$ $T_{vj}=150^{\circ}\text{C}$	V_F	2.35 2.55 2.45	3.0	V
反向恢复峰值电流 Peak reverse recovery current	$I_F=450\text{A}, V_R=600\text{V},$ $V_{GE}=-15\text{V}, R_G=2.0\Omega,$ $-diF/dt=3500\text{A/us}(T_{vj}=150^{\circ}\text{C})$	$T_{vj}=25^{\circ}\text{C}$ $T_{vj}=125^{\circ}\text{C}$ $T_{vj}=150^{\circ}\text{C}$	I_{RM}	211 297 316		A
恢复电荷 Recovered charge	$I_F=450\text{A}, V_R=600\text{V},$ $V_{GE}=-15\text{V}, R_G=2.0\Omega,$ $-diF/dt=3500\text{A/us}(T_{vj}=150^{\circ}\text{C})$	$T_{vj}=25^{\circ}\text{C}$ $T_{vj}=125^{\circ}\text{C}$ $T_{vj}=150^{\circ}\text{C}$	Q_F	18.14 42.54 51.06		μC
反向恢复损耗（每脉冲） Reverse recovered energy	$I_F=450\text{A}, V_R=600\text{V},$ $V_{GE}=-15\text{V}, R_G=2.0\Omega,$ $-diF/dt=3500\text{A/us}(T_{vj}=150^{\circ}\text{C})$	$T_{vj}=25^{\circ}\text{C}$ $T_{vj}=125^{\circ}\text{C}$ $T_{vj}=150^{\circ}\text{C}$	E_{rec}	7.20 18.22 22.08		mJ
结-外壳热阻 Thermal resistance, junction to case	每个二极管 / per diode	R_{thJC}			0.20	K/W
在开关状态下温度 Temperature under switching conditions		$T_{vj op}$	-40		150	$^{\circ}\text{C}$

负温度系数热敏电阻 / NTC-Thermistor

特征值 / Characteristic Values

Parameter	Conditions	Symbol	Value			Unit
			Min.	Typ.	Max.	
额定电阻值 Rated resistances	$T_c=25^{\circ}\text{C}, \pm 5\%$	R_{25}		5.0		$\text{K}\Omega$
B-值 B-value	$\pm 2\%$	$B_{25/50}$		3375		K

模块 / Module

Parameter	Conditions	Symbol	Value			Unit
绝缘测试电压 Isolation test voltage	RMS, f=50Hz, t=1min	V _{ISOL}	2500			V
内部绝缘 Internal isolation			Al ₂ O ₃			
储存温度 Storage temperature		T _{stg}	-40		125	°C
模块安装的扭矩 Mounting torque for modul mounting		M	3.0		6.0	Nm
端子联接扭距 Terminal connection torque		M	3.0		6.0	Nm
重量 Weight		W		340		g



图 1. 典型输出特性 ($V_{GE}=15V$)

Figure 1. Typical output characteristics ($V_{GE}=15V$)

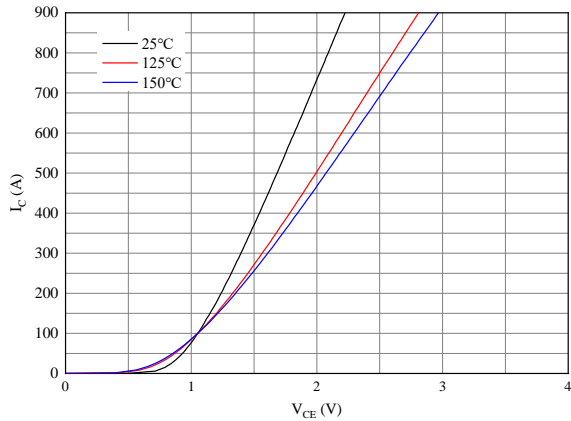

图 2. 典型输出特性 ($T_{vj}=150^{\circ}C$)

Figure 2. Typical output characteristics ($T_{vj}=150^{\circ}C$)

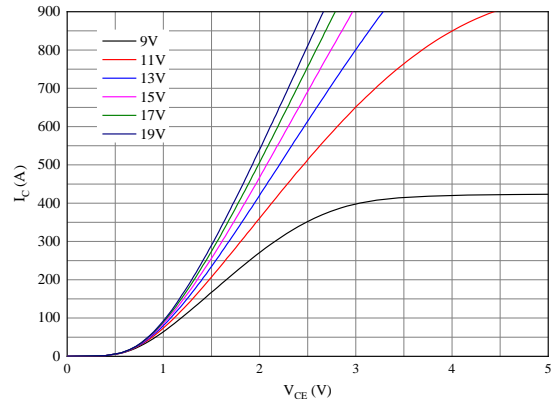

图 3. 典型传输特性 ($V_{CE}=20V$)

Figure 3. Typical transfer characteristic ($V_{CE}=20V$)

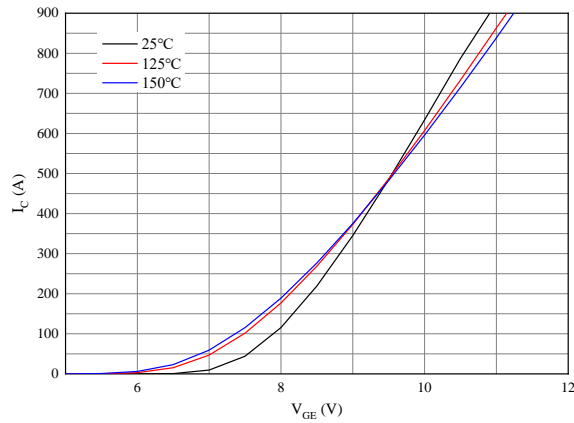

图 4. 正向偏压特性 二极管

Figure 4. Forward characteristic of Diode

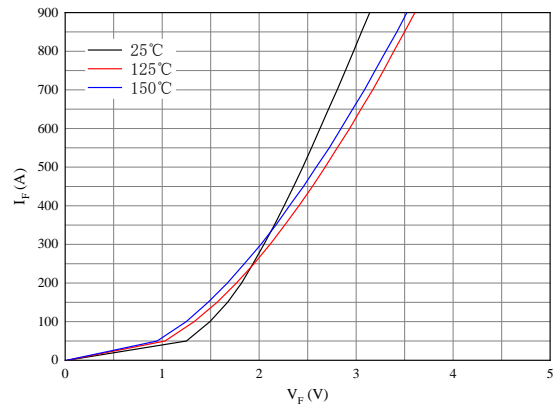

图 5. 开关损耗 逆变器

Figure 5. Switching losses of IGBT

$V_{GE}=\pm 15V, R_{Gon}=2.0\Omega, R_{Goff}=2.0\Omega, V_{CE}=600V$

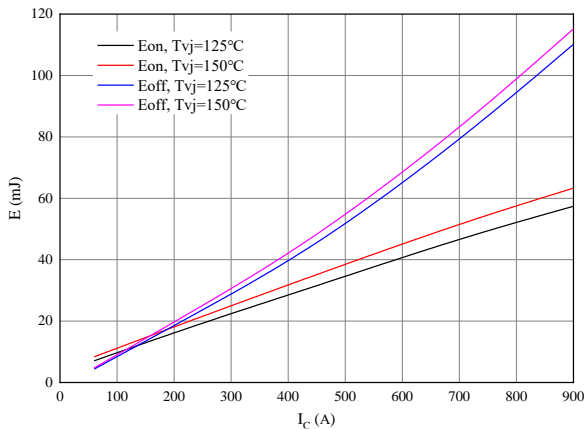

图 6. 开关损耗 逆变器

Figure 6. Switching losses of IGBT

$V_{GE}=\pm 15V, I_C=450A, V_{CE}=600V$

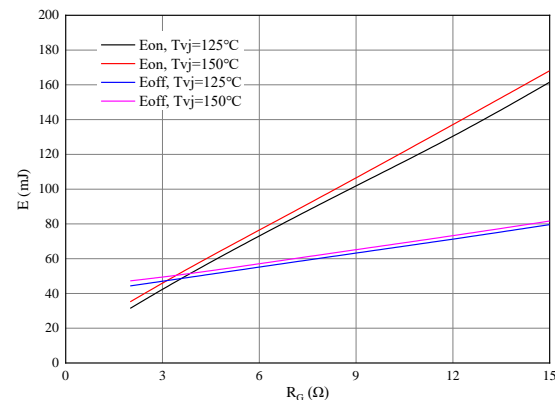

图 7. 开关损耗 二极管

Figure 7. Switching losses of Diode
R_{Gon}=2.0Ω, V_{CE}=600V

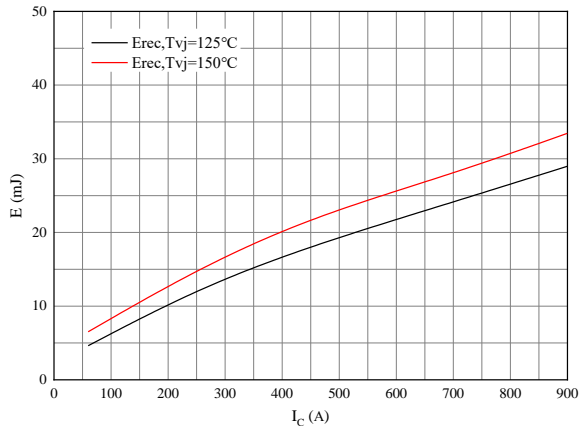

图 8. 开关损耗 二极管

Figure 8. Switching losses of Diode
I_C=450A, V_{CE}=600V

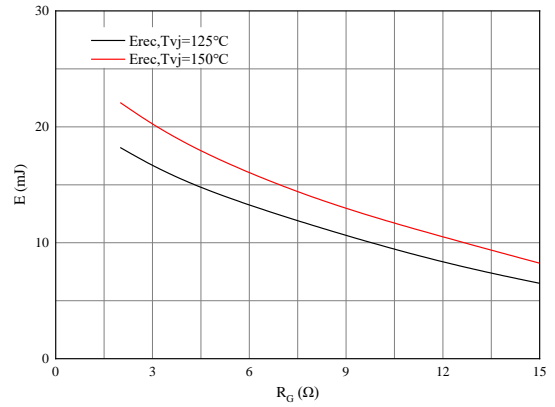

图 9. 电容特性

Figure 9. Capacitance characteristic

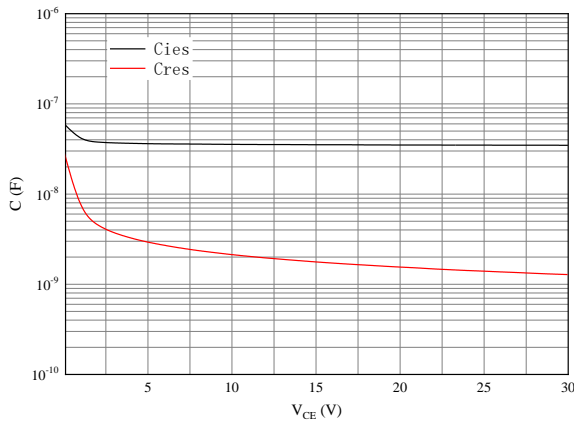

图 10. 负温系数热敏电阻 温度特性

Figure10. NTC-Thermistor-temperaturecharacteristic

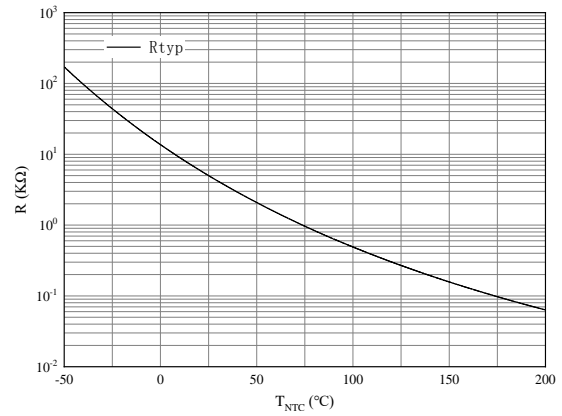

图 11. 瞬态热阻抗 IGBT 逆变器

Figure11. Transient thermal impedance IGBT,Inverter
Z_{thJC}=f(t)

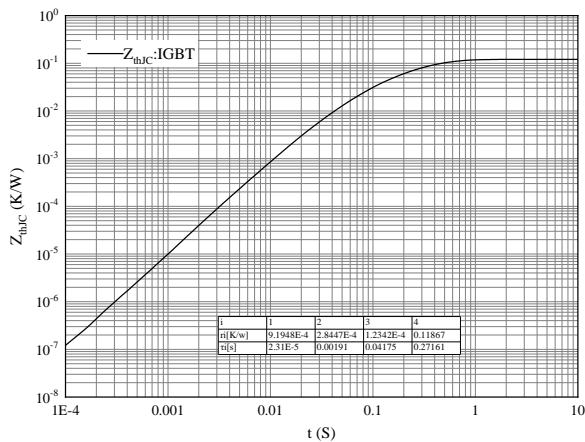

图 12. 瞬态热阻抗 FRD 逆变器

Figure12. Transient thermal impedance FRD ,Inverter
Z_{thJC}=f(t)

接线图 / Circuit diagram

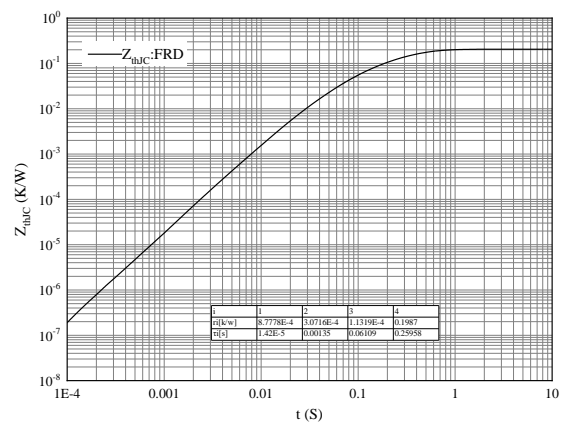
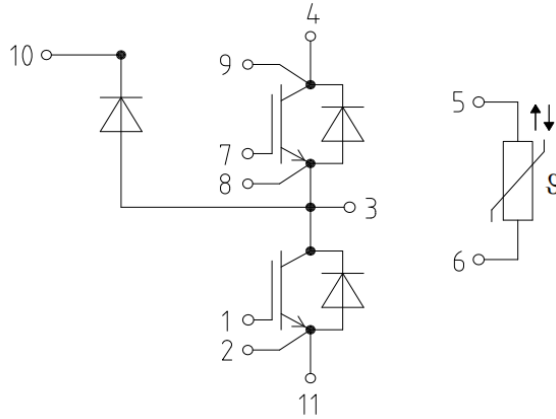

封装尺寸 / Package outlines

